



# eclipse

## ECLIPSE Expansion Module 1 Zone



PART DESCRIPTION	ECLIPSE EXPANSION MODULE - 1 ZONE
Part Number	60-0496 - ECLIPSE Expansion Module - 1 Zone
Ingress Protection Rating	IP67
Features	Add 1 Extra Zone to ECLIPSE Command Center Switch Control WiFi Control from Smart Device or Certified MFD Individual Zone Control Simple Installation Plug-and-Play Setup Dimming Color Selection Strobe Sound to Light (RGBW Lights Only)
Warranty	2 Years
Customer Control Options	Switch Input WiFi Control Via Smart Device or Certified MFD
Compatible With	All Lumishore ECLIPSE Above and Below Water Lights. Lumishore ECLIPSE Command Center

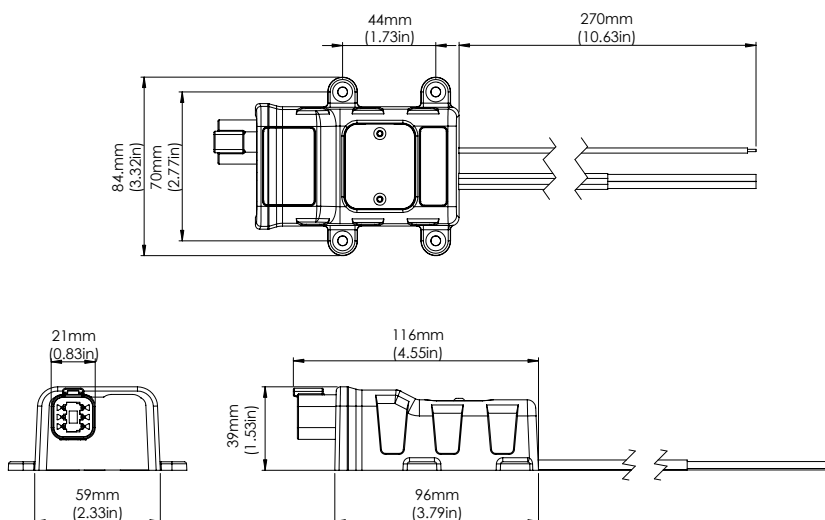

EMEA: [Info@Lumishore.com](mailto:Info@Lumishore.com) | USA: [Sales@LumishoreUSA.com](mailto:Sales@LumishoreUSA.com)

Units 11 & 12, Ashmount Business Park, Upper Fforest Way, Swansea, SA6 8QR | 7137 24th Court East, Sarasota, FL 34243, USA

## TECHNICAL

Supply Voltage Range	12V DC Only (10 - 15V DC)
Max Current Draw (12V DC)	10A (1 Zone of 10A)
Surge Protection	Yes
Number of Zones	1 Extra (making 4 with ECLIPSE Command Center)
Max Current Per Zone	10A
Max No. Lights Per Zone	16 (total current draw must be 10A or less)
Low Voltage Protection	Yes
Reverse Polarity Protection	Yes
ISO 8846 (Ignition Protection)	Yes

## PHYSICAL

Ingress Protection	IP67
Size - Not Including Cable Glands (LxWxH)	116mm (4.55") x 84mm (3.32") x 39mm (1.53")
Construction	Robust Weatherproof ABS (Flame Retardant and Halogen Free)
Weight	265g (9oz)

## ACCESSORIES

Expansion Module (Double Zone)	60-0497
--------------------------------	---------

## LIGHTING SYSTEM FUNCTIONALITY

ECLIPSE Lighting Compatible	All ECLIPSE Above Water and Underwater Lights
Zone Expansion	1 Extra Zone to ECLIPSE Command Center
Switch Control	Yes
WiFi Control from Smart Device or Certified MFD	Yes
Individual Zone Control	Yes - up to 16 Lights per Zone
Simple Installation	Yes
Plug-and-Play Setup	Yes
Dimming	Yes
Colour Selection	Yes
Sound to Light	Yes
Strobe	Yes



# eclipse

## ECLIPSE Expansion Module 2 Zone



PART DESCRIPTION	ECLIPSE EXPANSION MODULE - 2 ZONE
Part Number	60-0497 - ECLIPSE Expansion Module - 2 Zone
Ingress Protection Rating	IP67
Features	Add 2 Extra Zones to ECLIPSE Command Center Switch Control WiFi Control from Smart Device or Certified MFD Individual Zone Control Simple Installation Plug-and-Play Setup Dimming Color Selection Strobe Sound to Light (RGBW Lights Only)
Warranty	2 Years
Customer Control Options	Switch Input WiFi Control Via Smart Device or Certified MFD
Compatible With	All Lumishore ECLIPSE Above and Below Water Lights. Lumishore ECLIPSE Command Center

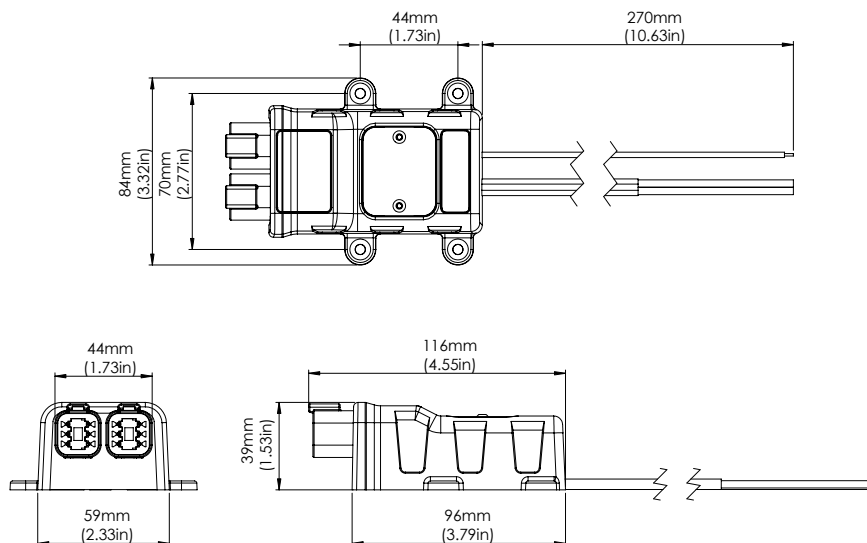

EMEA: [Info@Lumishore.com](mailto:Info@Lumishore.com) | USA: [Sales@LumishoreUSA.com](mailto:Sales@LumishoreUSA.com)

Units 11 & 12, Ashmount Business Park, Upper Fforest Way, Swansea, SA6 8QR | 7137 24th Court East, Sarasota, FL 34243, USA

## TECHNICAL

Supply Voltage Range	12V DC Only (10 - 15V DC)
Max Current Draw (12V DC)	20A (2 Zones of 10A)
Surge Protection	Yes
Number of Zones	2 Extra (making 5 with ECLIPSE Command Center)
Max Current Per Zone	10A
Max No. Lights Per Zone	16 (total current draw must be 10A or less)
Low Voltage Protection	Yes
Reverse Polarity Protection	Yes
ISO 8846 (Ignition Protection)	Yes

## PHYSICAL

Ingress Protection	IP67
Size - Not Including Cable Glands (LxWxH)	116mm (4.55") x 84mm (3.32") x 39mm (1.53")
Construction	Robust Weatherproof ABS (Flame Retardant and Halogen Free)
Weight	265g (9oz)

## ACCESSORIES

Expansion Module (Single Zone)	60-0496
--------------------------------	---------

## LIGHTING SYSTEM FUNCTIONALITY

ECLIPSE Lighting Compatible	All ECLIPSE Above Water and Underwater Lights
Zone Expansion	2 Extra Zones to ECLIPSE Command Center
Switch Control	Yes
WiFi Control from Smart Device or Certified MFD	Yes
Individual Zone Control	Yes - up to 16 Lights per Zone
Simple Installation	Yes
Plug-and-Play Setup	Yes
Dimming	Yes
Colour Selection	Yes
Sound to Light	Yes
Strobe	Yes