



SUPRA Series - Dual Color THX403

THRU-HULL UNDERWATER LED LIGHT

PART DESCRIPTION	SUPRA THX403 THRU-HULL UNDERWATER LED LIGHT
Part Number	60-0344
Available Colors	Dual Color (Blue & White)
Lumens	16,650
Fixture Lumens (White)	7,400
Number & Type Of LED	White - 12 x 10W, Blue - 24 x 3W
LED Power - HICOB Array	Yes
Typical LED Life	50,000+ Hours
Warranty	3 Years
User Control Options	SUPRA i-Connect Hub & Switch Certified MFD Screen* Lumi-Link Display STV 2204i* WiFi control from Smart phone or Connected Device (via MFD or local WiFi Network)*

* Requires SUPRA Lumi-Link Bridge Module

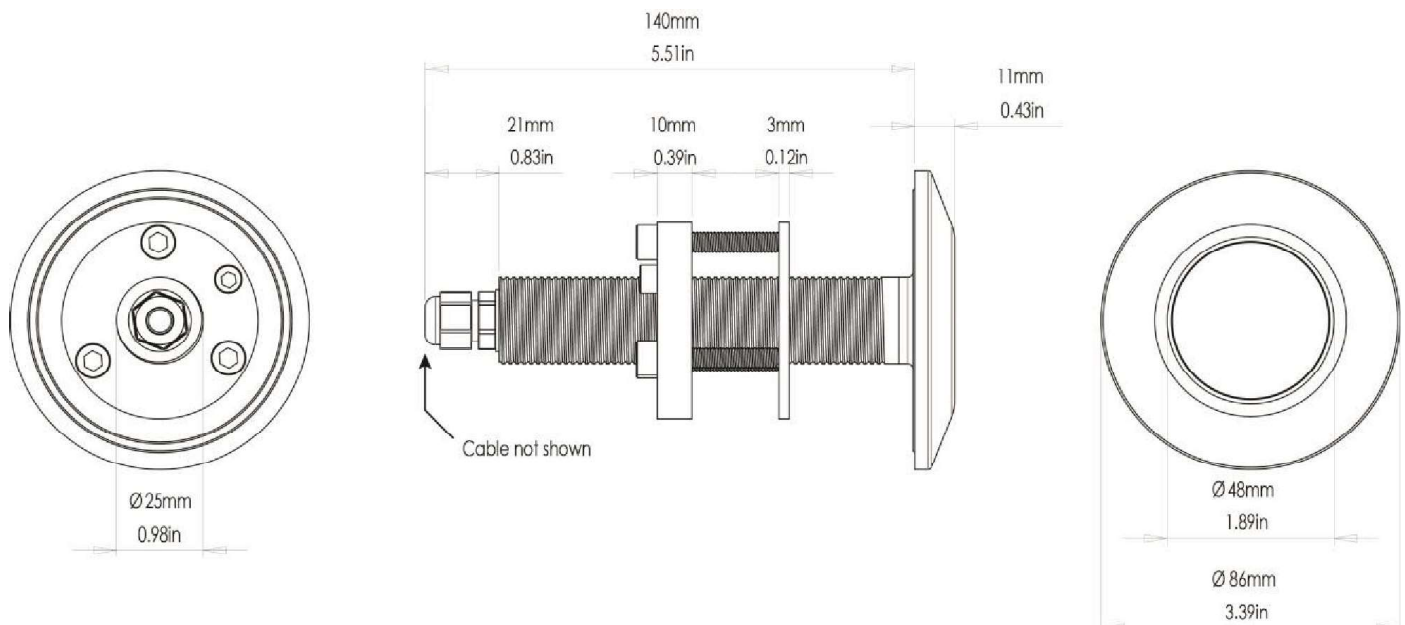

SUPRA Series - Dual Color

THX403

THRU-HULL UNDERWATER LED LIGHT



TECHNICAL	
Driver	Multi-Channel External Driver
Supply Voltage Range	10.5–31 V DC**
Max Current Draw 12/24V	6.4 A / 3.2 A
Surge Protection	Yes (3,000V)
ATRB (Automatic Thermal Roll-Back)	Yes
Low Voltage Protection	Automatic Voltage Roll-Back Control And Low Voltage Cut Out
Auto Power Control	Yes - Intelligent Multi-Channel Power Management
“Soft Start” Electronics Protection	Yes
Reverse Polarity Protection	Yes
In Rush Current Protection	Yes
Power Line Noise Suppression	Yes
Connections	Plug and Play

**AC Options Available – Contact Lumishore for more information

PHYSICAL	
Beam Angle	110°
Water Ingress Protection Rating	IP68
Light Face Diameter	86mm (3.39")
Profile (Height) Of Housing	11mm (0.43")
Shaft Length	140mm (5.51")
Housing Type	Marine Bronze Body with Borosilicate Glass Lens
Light Cable Length	3m (9.8') Standard
Hole Cut-Out for Shaft (Hole Cutter Size)	Metric: 27mm Imperial: 1-1/16 " (1.0625")
Weight	0.66 Kg (1.46 Lbs)
Bonding	Required (Bonding Connection Provided on Light)
Isolation Option	Hull Isolation Sleeves Available For Metal Hull Installation

LIGHTING SYSTEM FUNCTIONALITY (I-CONNECT HUB & SWITCH)	
Mode	Toggle switch to move to the next mode
White	Yes
Blue	Yes
Strobe	Yes
Synchronized Strobe	Yes
Fade Mode	Yes
Synchronized Fade Mode	Yes
Light Control via MFD Screen or Lumi-Link 2204i Display	Yes*

*These features require a SUPRA Lumi-Link Bridge Module and compatible MFD. This allows easy integration and control direct from MFDs, and other third party control systems.

ACCESSORIES	PART NUMBER
THX/TIX-SUPRA i-Connect Installation Kit (i-Connect Switch & i-Connect Hub)	60-0329
Additional i-Connect Hub	60-0330
3m Extension cable (Driver to Hub)	60-0401
Hull Isolation Kit	60-0207
SUPRA Lumi-Link Bridge Module	60-0368

LUMI-LINK™

PLUG-&-PLAY MFD INTEGRATION

The world's first marine lighting API (Application Programming Interface) allowing plug-&-play integration of Lumishore SUPRA & EOS underwater lighting systems with a single cable to your certified Multi-Function Display (MFD) creating a centralized control platform for the entire vessel reducing helm clutter and simplifying vessel operation. Now available for Garmin OneHelm™ MFDs.